

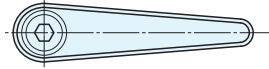

把手			入子	
材質	處理	顏色	材質	顏色
鋅合金	塗裝	橘、黑	鋼	染黑

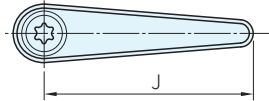

內六角孔



星型孔

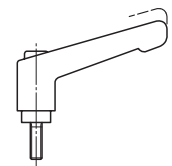
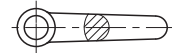
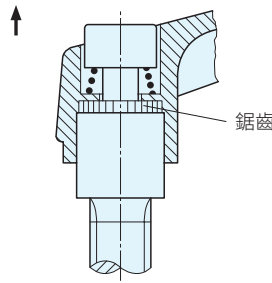
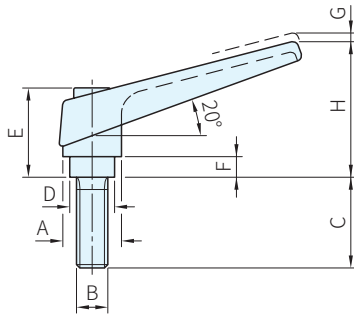

SIZE M4

橘色 品號	黑色 品號	A	B	C	D	E	F	G	H	J	質量 g	庫存							
24400.0010	24400.0012	13	M4	12	10.0	24.5	4.0	3.5	30.5	30	27	•							
24400.0014	24400.0016			16							•								
24400.0018	24400.0020			20							•								
24400.0022	24400.0024			25							•								
24400.0026	24400.0028			32							•								
24400.0041	24400.0044	14	M5	12	13.5	31.0	6.5	3.0	45.0	45	36	•							
24400.0051	24400.0054			16							•								
24400.0061	24400.0064			20							•								
24400.0071	24400.0074			25							•								
24400.0081	24400.0084			32							•								
24400.0086	24400.0089		40	•															
24400.0131	24400.0134		18	M6							12	13.5	31.0	6.5	45.0	45.0	62	37	•
24400.0141	24400.0144										16							•	
24400.0151	24400.0154										20							•	
24400.0161	24400.0164										25							•	
24400.0171	24400.0174	32			•														
24400.0181	24400.0184	40			•														
24400.0191	24400.0194	50			•														
24400.0221	24400.0224	16			•														
24400.0231	24400.0234	20	•																
24400.0241	24400.0244	25	•																
24400.0251	24400.0254	32	•																
24400.0261	24400.0264	40	•																
24400.0271	24400.0274	50	•																
24400.0281	24400.0284	63	•																

橘色 品號	黑色 品號	A	B	C	D	E	F	G	H	J	質量 g	庫存
24400.0331	24400.0334	18	M8	16	13.5	31.0	6.5	3.0	45.0	62	74	•
24400.0341	24400.0344			20							76	•
24400.0351	24400.0354			25							78	•
24400.0361	24400.0364			32							80	•
24400.0371	24400.0374			40							81	•
24400.0381	24400.0384			50							84	•
24400.0391	24400.0394			63							89	•
24400.0441	24400.0444			20							128	•
24400.0451	24400.0454	25	130	•								
24400.0461	24400.0464	32	134	•								
24400.0471	24400.0474	40	138	•								
24400.0481	24400.0484	50	143	•								
24400.0486	24400.0489	63	148	•								
24400.0491	24400.0494	80	157	•								
24400.0541	24400.0544	25	205	•								
24400.0551	24400.0554	32	209	•								
24400.0561	24400.0564	40	215	•								
24400.0571	24400.0574	50	222	•								
24400.0581	24400.0584	63	232	•								
24400.0591	24400.0594	80	244	•								
24400.0641	24400.0644	32	348	•								
24400.0651	24400.0654	40	357	•								
24400.0661	24400.0664	50	370	•								
24400.0671	24400.0674	63	386	•								
24400.0681	24400.0684	80	407	•								

WA. 注意

・把手內六角孔售完將改以星型孔出貨

訂貨： 交期： 天

24400.0010

SP. 特長

・把手位置上拉後可自由調整，放鬆後齒合復位

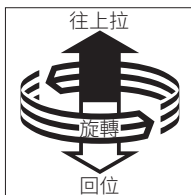
**EX. 使用例**